

PACKAGE CONTENTS

* 1x PoE switch	* 1x Quick Installation Guide
* 1x T25 L-wrench	* 1x Console Cable

⚠ IMPORTANT:

1. Install the PoE switch in a ventilated and dry place that is free of electromagnetic source, vibration, moisture, and dust.
2. Make sure the ventilation openings on the switch are not blocked.
3. Use CAT5 or 5e UTP/STP cables.
4. AC input (100~240V/AC, 50~60HZ) for a max. consumption of 120W.
5. IP67 rated housing.
6. Although housing is IP67 rating , this is not suitable for water jets.

CONNECTION

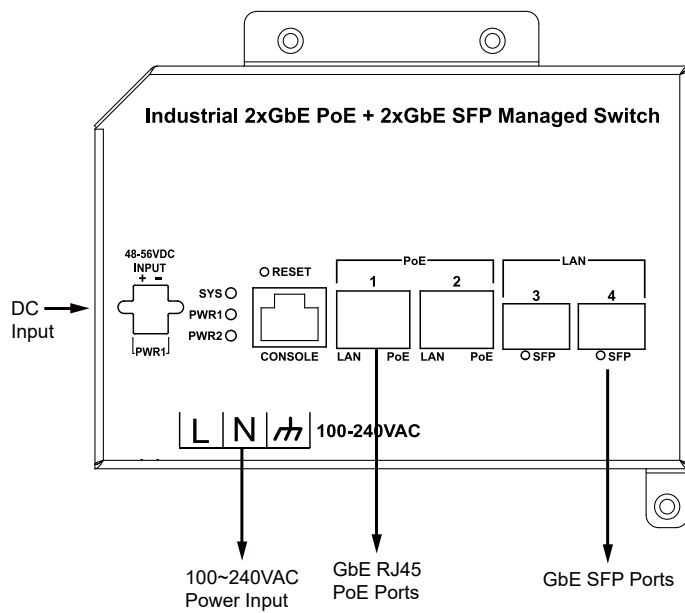

AC Power Cable Spec.

Wire Size	10~18AWG
Wire Strip Length	8mm

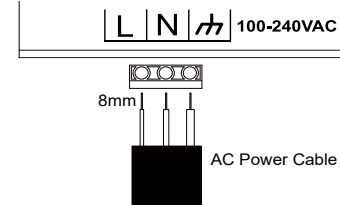

DC Power Cable Spec.

Wire Size	10~18AWG
Wire Strip Length	8mm

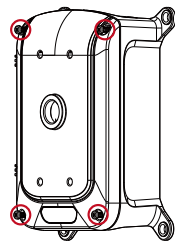
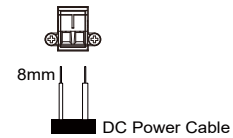

1. Loosen the screws

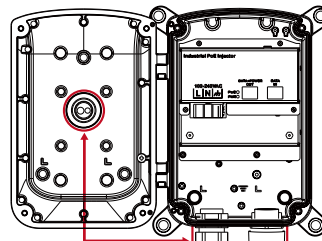

2. Install the cable glands

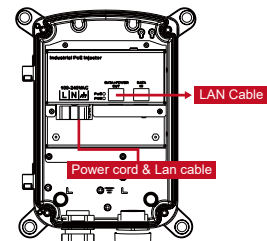

3. Connect the cables

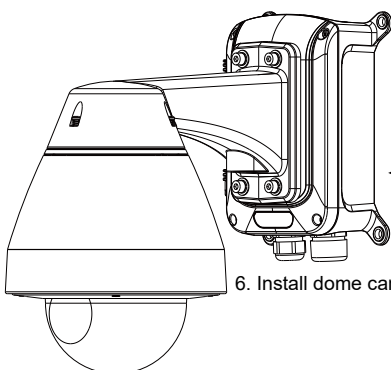

6. Install dome camera

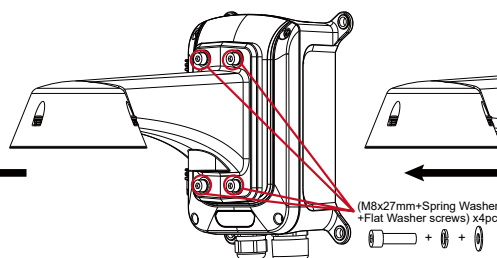

5. Fixed pendant wall mount

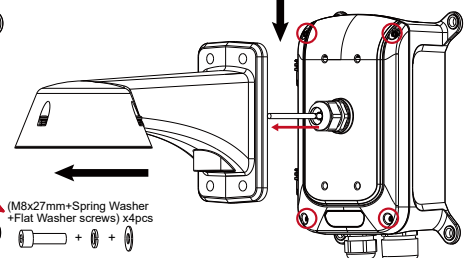

4. Tighten the screws

Reset button

Task	Method	SYS LED Behavior	Port Status LED Behavior
Reset	Press 2 ~ 7 seconds	Blinking Green	All LEDs Off.
Restore Defaults	Press 7 ~ 12 seconds	Blinking Green	All LEDs On.

DEFAULTS

IP Address	192.168.1.1
Subnet Mask	255.255.255.0
User Name	admin
Password	admin

Console Port Defaults

Baud rate	115200
Stop bits	1
Data bits	8
Parity	N
Flow control	none

Power LEDs

LED	Color	State	Description
Power1	Green	On	Powered on correctly.
		Off	Not receiving power from power1.
Power2	Green	On	Powered on correctly.
		Off	Not receiving power from power1.

The cabinet must be grounded using a ground wire between the ground screw and earth ground.

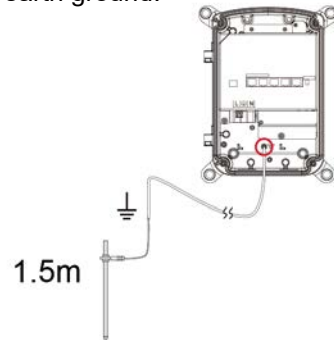

Port Status LEDs

LED	Color	State	Description
RJ45 Ports (PoE)	Amber	On	The port is enabled and supplying power to connected device.
	-	Off	The port has no active connection, or it is not connected to a PoE PD device. Otherwise, the port may have been disabled through the switch user interface.
RJ45 Ports (LAN)	Green	On	The port is enabled and established a link to connected device.
	Green	Blinking	The port is transmitting/receiving packets.
	-	Off	The port has no active network connection, or it has no established link to connected device. Otherwise, the port may have been disabled through the switch user interface.
SFP Ports	Green	On	The port is enabled and established a link to connected device,
	Green	Blinking	The port is transmitting/receiving packets.
	-	Off	The port has no active network connection, or it has no established link to connected device. Otherwise, the port may have been disabled through the switch user interface.

INSTALLATION

Use the included M10 hex socket screws to secure the power box to a pole-mount or corner mount bracket.

The mounting hole definition is illustrated below. The same mounting hole pattern apply to all pole-mount and corner-mount brackets.

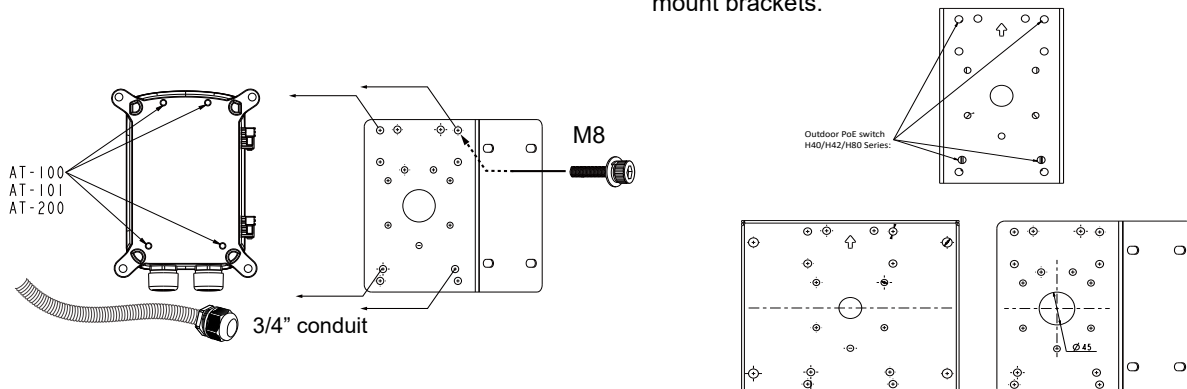

All specifications are subject to change without notice.
Copyright © 2023 AETEK INC. All rights reserved.