

# H36-042-30-V2

Industrial Gigabit PoE Switch w/ 12~56VDC Input



Fiber-Optical



30W PoE

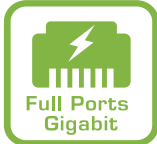

Full Ports  
Gigabit

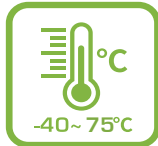

-40~75°C



12V~56VDC  
INPUT

## Features

- 12V~56VDC Input Power
- Flexible SFP transceiver port for uplink
- Operating temperature between -40°C and 75°C
- 30W@56VDC IEEE802.3at PoE port x4
- Supporting 10/100/1000Mbps data rates
- IEEE 802.3az Energy Efficient Ethernet standard for green power



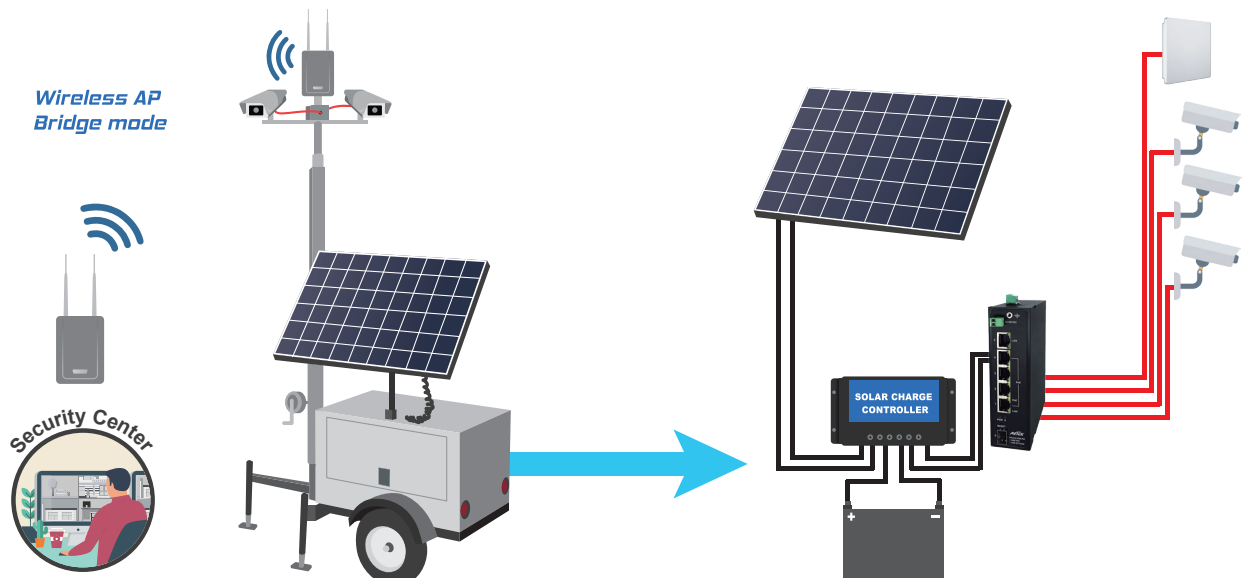
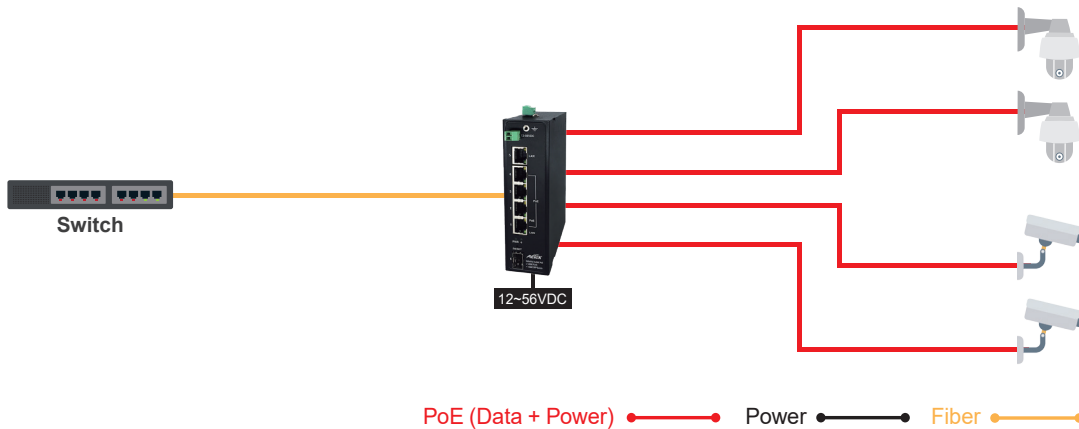

## Applications





## Specifications

H36-042-30-V2	
<b>Networking Specifications</b>	
Total Gigabit Ports	6
Gigabit Ports (RJ45)	1
SFP Slots (100M/1G)	1
30W IEEE802.3 at Power over Ethernet	support
Forwarding Capacity	11.904Mpps
Mac Table	4K
Jumbo Frames	9,216 Bytes
Switching Capacity	12Gbps
<b>Power Specifications</b>	
Input Voltage	12V~56VDC
Output Voltage Range / port 1~port 4	56VDC PoE IEEE 802.3af (Max. 15.4W) output PoE+ IEEE802.3at (Max. 30W) output
PoE Power Budget	12VDC:75W 24VDC:120W 48VDC:120W
Power Consumption	5W
<b>Mechanical Specifications</b>	
Dimensions (L x W x H)	140 X 40 X 102 mm
Weight	0.59kg (1.3 lb)
Connectors	RJ45x5, SFP Slotx1, Terminal block x2
Installation	Din-Rail & Wall-Mount
<b>Environmental Specifications</b>	
Operating Temperature	-40°C ~ 75°C (-40°F ~ 167°F)
Storage Temperature	-40°C ~ 85°C (-40°F ~ 185°F)
Operating Humidity	5% ~ 95% non-condensing
<b>Certifications</b>	
EMC	CE, FCC, VCCI, C-Tick

## Optional Accessories

SFP Modules			
 <p><b>SFP-ISX-X5</b> Industrial Gigabit SFP Transceiver</p> <ul style="list-style-type: none"> <li>• MMF</li> <li>• 0.5 km</li> <li>• -40°C ~85°C</li> </ul>	 <p><b>SFP-ISX-02</b> Industrial Gigabit SFP Transceiver</p> <ul style="list-style-type: none"> <li>• MMF</li> <li>• 2 km</li> <li>• -40°C ~85°C</li> </ul>	 <p><b>SFP-ILX-10</b> Industrial Gigabit SFP Transceiver</p> <ul style="list-style-type: none"> <li>• SMF</li> <li>• 10 km</li> <li>• -40°C ~85°C</li> </ul>	 <p><b>SFP-ILX-40</b> Industrial Gigabit SFP Transceiver</p> <ul style="list-style-type: none"> <li>• SMF</li> <li>• 40 km</li> <li>• -40°C ~85°C</li> </ul>

Power Supply	
 <p><b>NDR-120-48</b> Indoor Industrial Din Rail Power Supply, 48~55VDC/120W, -20°C ~ 70°C</p>	 <p><b>NDR-240-48</b> Indoor Industrial Din Rail Power Supply, 48~55VDC/240W, -20°C ~ 70°C</p>