

Model	Description
D40-044-30	4xGbE 30W PoE + 2xGbE RJ45 + 2xGbE SFP
D40-044-91	4xGbE 90W bt PoE + 2xGbE RJ45 + 2xGbE SFP
D40-082-30	8xGbE 30W PoE + 2xGbE SFP

Model	Description
D40-044-91-DC	4xGbE 90W bt PoE + 2xGbE RJ45 + 2xGbE SFP 12-56V DC Input
D40-082-30-DC	8xGbE 30W PoE + 2xGbE SFP, 12-56V DC Input

PACKAGE CONTENTS

* 1x PoE switch	* 1x Quick Installation Guide	* 1x DIN rail bracket
* 1x 4pin terminal block		

⚠ IMPORTANT:

1. Install the PoE switch in a ventilated and dry place that is free of electromagnetic source, vibration, moisture, and dust.
2. Make sure the ventilation openings on the switch are not blocked.
3. Use fiber optic cables and transceiver compliant with the following: Multi-mode: 50/125um, 62.5/25um, 850nm; Single-mode : 9/125um ,1310nm.
4. DC input. Follow the printed polarity for V+, V-, and Ground.

CONNECTION

1. Pull out the 4-pin terminal block.
2. Connect power wires to V+ and V-, Use a flatblade screwdriver to secure the wire-clamp screws.
3. Connect SFP transceiver to the fiber port.
4. Install the 4-pin terminal block, and check power LED.
5. The switch must be grounded properly by using a ground wire to connect switch ground screw to earth ground, otherwise, the surge protection level will be greatly reduced.

Power LEDs

LED	Color	State	Description
Power	Green	ON	The switch is powered on correctly.
		Off	Not receiving power from power 1 or power 2.
PoE Link	Amber	ON	PD is detected on the designated port.
		Off	No PD is detected.
Data Link	Green	ON	Tx link is detected.
		Off	Link is not detected.
		Flashing	Data is being transmitted or received.
SFP Link	Green	ON	Fiber link is detected.
		Off	Fiber link is not detected.
		Flashing	Data is being transmitted or received.

All Specifications are subject to change without notice.

RESET

Reset the switch	3 seconds	Blinking Green	All LEDs off
------------------	-----------	----------------	--------------

⚠ IMPORTANT:

Ground screw

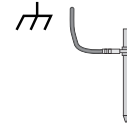

Solid or stranded (AWG): 12-24/14-22

Wire strip length: 7-8mm

Torque: 5lb-In/0.5Nm/0.56Nm

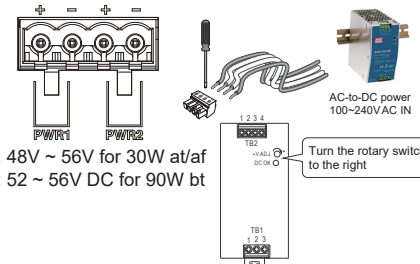

DC: 48V ~ 56V for 30W at/af
DC: 52 ~ 56V DC for 90W bt

D40-044-30
D40-044-91

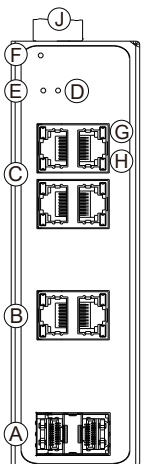

D40-082-30

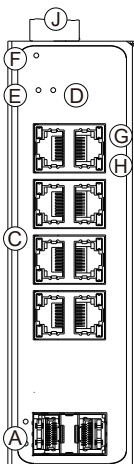

D40-044-91-DC

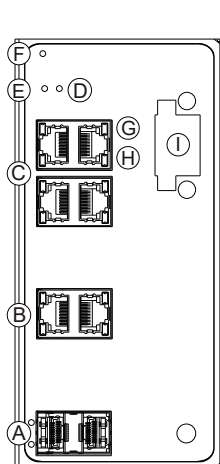

D40-082-30-DC

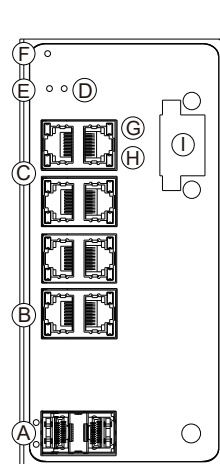

- (A) GbE SFP ports
- (B) RJ45 ports
- (C) GbE PoE RJ45 ports
- (D) Power1 LED
- (E) Power2 LED
- (F) Reset button
- (G) PoE link LED
- (H) Data link LED
- (I) 12~56V DC Input
- (J) 48~56V DC Input

Ground loops

Do not connect the power supply negative or Battery negative terminal of our device to the chassis or earth exclusively.

This connection could cause ground loops. For example, if the Battery negative and power supply negative terminal are connected to the chassis or earth, it forms a ground loop, therefore unwanted current could flow through a device PCB ground and may cause damage.

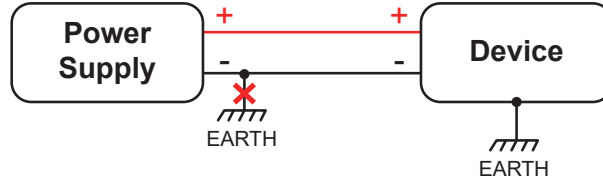

⚠ Power on

- ▶ Power on: First insert the power terminal of the power cable into the power port of the device, then plug in the power plug and power on. After the Switch is started, the Switch automatically initializes. If all port indicators are on and then off, the system is successfully reset, the power LED indicator will always stay on.
- ▶ Power off operation: Unplug the power plug first, and then remove the wiring part of the terminal. Please pay attention to the above operation sequence.

⚠ Warning:

Do not operate the device with input voltage approaching or exceeding 57V DC. Doing so may trigger protective shutdown of PoE and DC outputs.

Installation

DIN Rail Installation

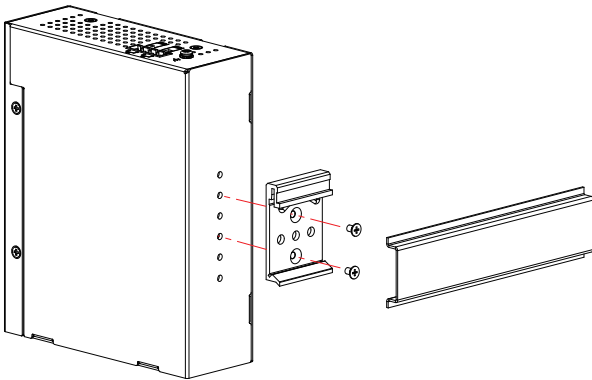

Wall Mount Installation

D40-044-91-DC / D40-082-30-DC only

