



# S2000-I

## AISI 316L Stainless Steel 24VAC Camera Housing

AETEK's S2000-I camera housing constructed by AISI 316L stainless steel designed to protect IP & analog box/brick camera in highly corrosive & severe environments such as offshore, chemical, petrochemical, and tunnel areas. Besides built-in window heater & blower to preventing from ice & mist on window. S2000-I is compliant to IP68, and IK10 standards. This model is powered by 24VAC input and provides 12VDC & 24VAC output inside housing. The unparalleled built-in 12W VAIR illuminator is adjustable on beam angle by remote control thru RS485 Pelco-D command or manual dip switch to suit camera's FOV. Furthermore, the inner capacious spaces suits camera equipped with wide angle & long distance lens.

### Features

- AISI 316L stainless steel construction
- Fits corrosive & severe environments
- Built-in 12W VAIR Illuminator up to 140m
- Long range of built-in 12W VAIR Illuminator up to 140m at 10°
- Wide range of built-in 12W VAIR Illuminator up to 50m at 40°
- IP68 weather rating standards
- IK10 impact rated on stainless steel outer shell
- Window heater & blower included
- Supports wide-angle & long-distance remote focus lens
- Adjustable AISI 316L sunshield

### VAIR Illuminator Technology

VAIR technology is optical technology to adjust illuminator beam angle by remote control RS485 Pelco-D command or manual dip switch to suit camera FOV.

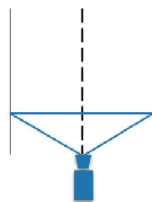
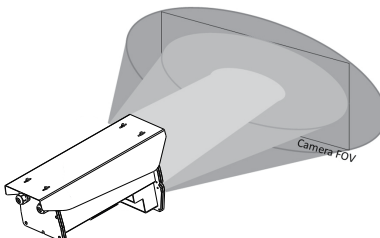

Wide angle for short distance

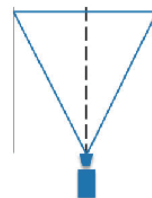

Tele angle for long distance

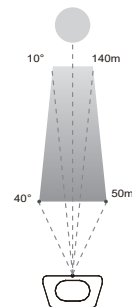

### Maximum Camera Length

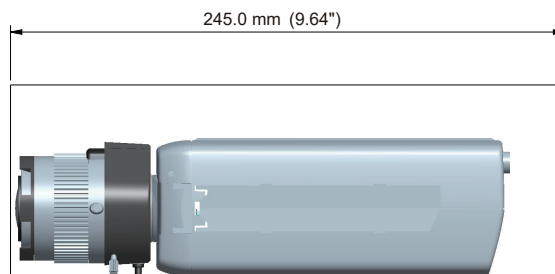
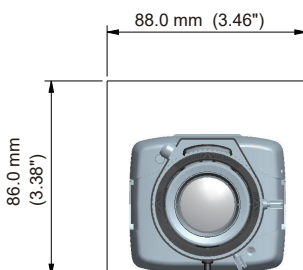

# Specifications

## Power Specifications

Power Input	24VAC
Power Output	12VDC, 24VAC
Unit Power Consumption	Blower: 2W IR LED: 12W Window Heater: 5W
VAIR Illuminator	850nm, 50m@40°, 140m@10°

## Physical Specifications

Window	Glass w/ heater
Body Material	AISI 316L stainless steel
Body Weight	8 kg
Cable Grants	PG16 x 2

## Environmental Specifications

Operating Temperature	-20°C ~ 65°C (-4°F ~ 149°F) -20°C ~ 50°C (w/IR LEDs)
Heater ON / OFF	≤ 20°C (68°F) ON ≥ 30°C (86°F) OFF
Blower ON / OFF	≤ 35°C (95°F) ON ≥ 25°C (77°F) OFF
Weather Rating	IP68
Vandal Proof	IK10 Impact Rated on AISI 316L Stainless Steel Housing

## Certifications

EMC	CE, FCC, C-Tick
-----	-----------------

## LEDs

PWR	System power status
-----	---------------------

## Dimensions

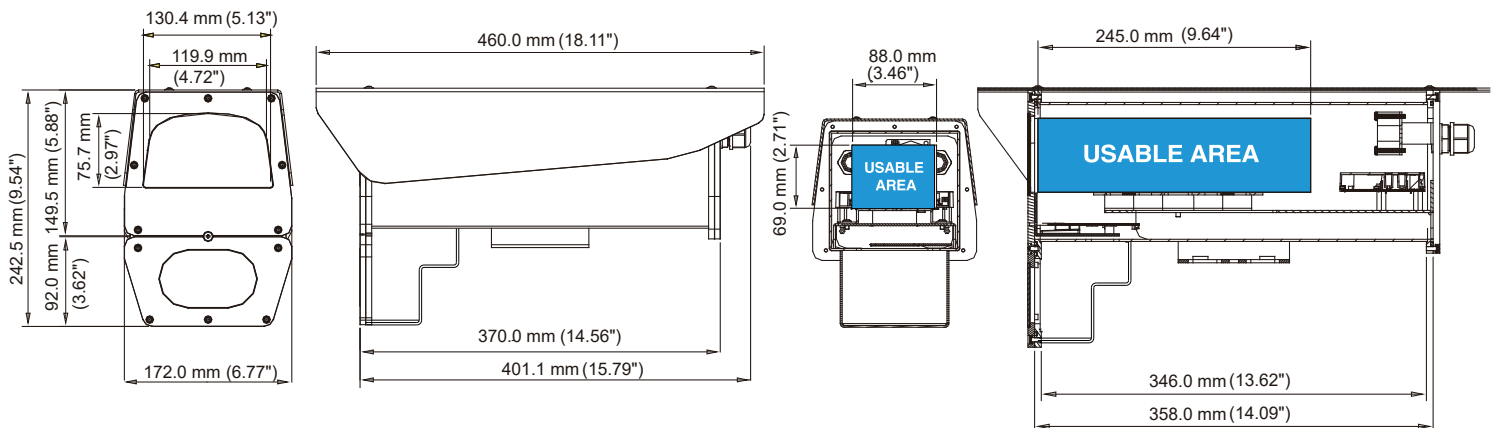

## Accessories

