

S6000-IW



AISI 316L Stainless Steel bt PoE Camera Housing

AETEK's S6000-IW camera housing constructed by AISI 316L stainless steel is designed to protect IP box/brick camera in highly corrosive & severe environments such as offshore, chemical, petrochemical, and tunnel areas. Besides built-in heater & blower to prevent from ice & mist on window, S6000-IW has built-in wiper and is compliant to IP66, and IK10 standards. An bt PoE (90W) power input is obligatory for this robust housing providing PoE & 24VDC output inside housing. S6000-IW is a new generation of camera housing equipped with built-in 12W VAIR illuminator that is adjustable on beam angle by remote control thru RS485 Pelco-D command or manual dip switch to suit camera's FOV. Furthermore, the inner capacious spaces suits camera equipped with wide angle & long distance lens.

Features

- AISI 316L stainless steel construction
- Fits corrosive & severe environments
- 90W bt PoE input is obligatory
- Built-in 12W VAIR Illuminator up to 140m
- Long range of built-in 12W VAIR Illuminator up to 140m at 10°
- Wide range of built-in 12W VAIR Illuminator up to 50m at 40°
- IP68 weather rating standards
- IK10 impact rated on stainless steel outer shell
- Built-in Wiper
- Window heater & blower included
- Plug-and-play over a single network cable
- Supports wide-angle & long-distance remote focus lens
- Adjustable AISI 316L sunshield

VAIR Illuminator Technology

VAIR technology is optical technology to adjust illuminator beam angle by remote control RS485 Pelco-D command or manual dip switch to suit camera FOV.

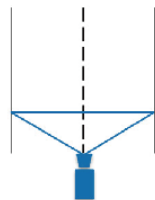
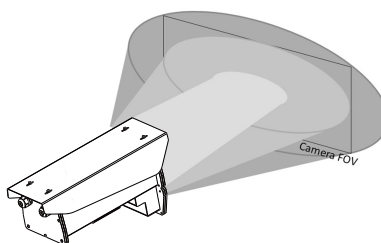

Wide angle for short distance

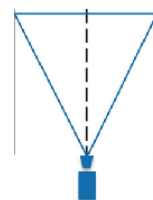

Tele angle for long distance

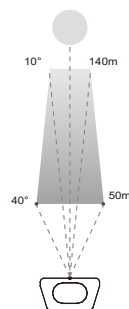

Maximum Camera Length

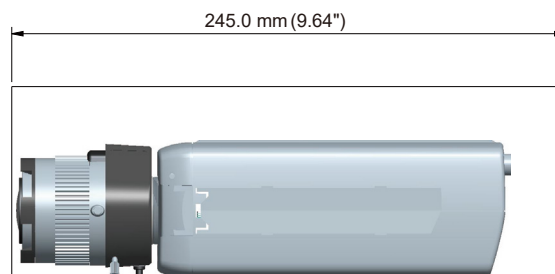
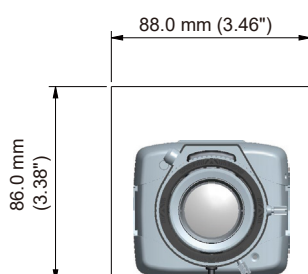

Specifications

Power Specifications

Data rate	10/100/1000M bps
Power Input	30W at / 60W bt / 90W bt PoE, 50~57VDC
Power Output	24VDC/48W
Max Output Power Budget	24W thru 30W PoE PSE 48 W thru 60W PoE PSE 72 W thru 90W PoE PSE
Camera Power Input	24W Passive PoE (Compliant IEEE 802.3af PoE)
Unit Power Consumption	Window Heater: 10W Blower: 2W Camera: 6 ~ 8W Wiper: 6W IR LED : 12W
VAIR Illuminator	850nm, 50m@40°, 140m@10°
Optional 10L Water Tank & Pump	TP-100: 12 W

Physical Specifications

Window	Glass w/ heater
Body Material	AISI 316L stainless steel
Body Weight	8.2 kg
Cable Grants	PG16 x 2

Environmental Specifications

Operating Temperature	-20°C ~ 65°C (-4°F ~ 149°F) -20°C ~ 50°C (w/IR LEDs) Wiper is functional at -10°C to + 60°C (14°F to 140°F)
Heater ON / OFF	≤20°C (68°F) ON ≥30°C (86°F) OFF
Blower ON / OFF	≤35°C (95°F) ON ≥25°C (77°F) OFF
Weather Rating	IP66
Vandal Proof	IK10 Impact Rated on AISI 316L Stainless Steel Housing

Certifications

EMC	CE, FCC, C-Tick
-----	-----------------

LEDs

PWR	System power status
PoE	PoE PD status

Dimensions

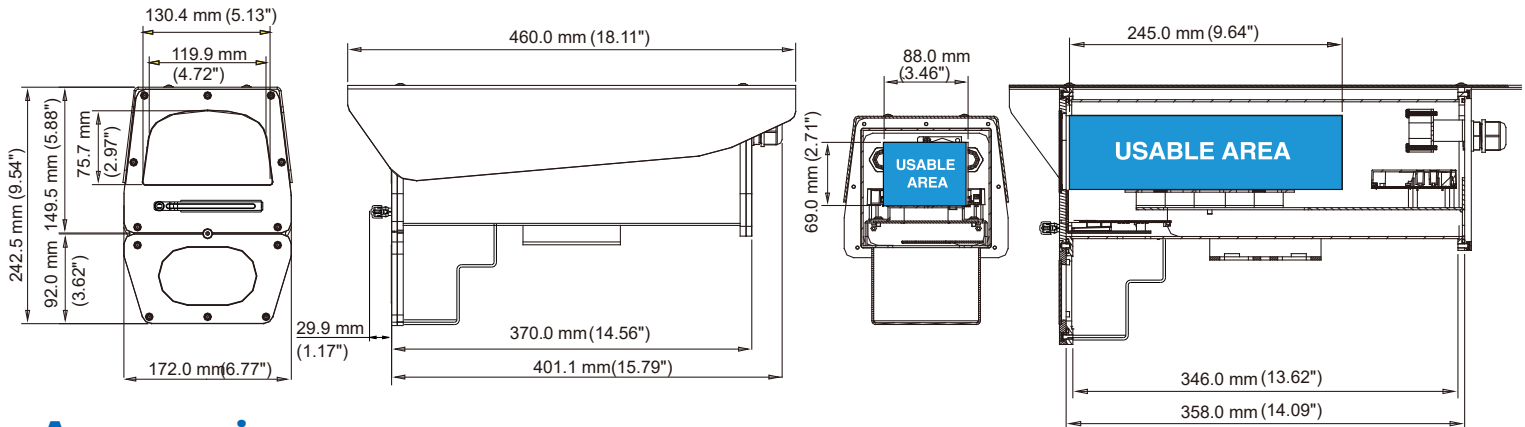

Accessories

