

P2900-AIW

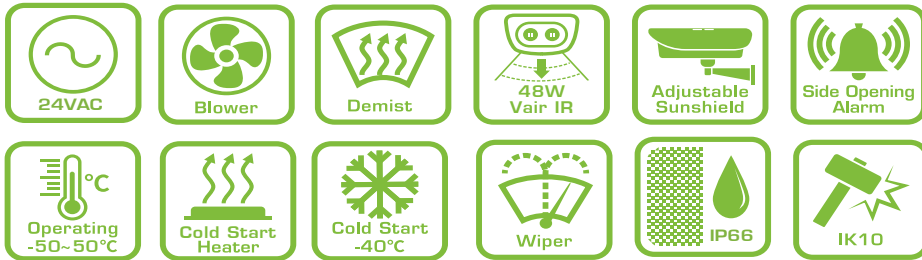

AC24V (DC24V Optional) ANPR Camera Housing



Video Clip Link

A safety city depending on ANPR implementation is becoming increasingly important. AETEK provides a series of all-in-one capacious ANPR camera housing fitting most of today's box/fixed cameras even equipped with 8-80mm varifocal lens. The camera housing is constructed from aluminum die casting to meet IP66/IK10 standards. These professional models are equipped with heater, blower, wiper, and built-in snapped in 48W IR LEDs specially using VAIR-IR technology to cover 2-lane ANPR detection. Besides elegant mechanical design, IR illuminator is snapped in camera housing directly to conceal RS-485 & power cables.

The ANPR camera housing series has 2 sub models supported by AC24V individually. P2900-IW & P2900-AIW are powered thru AC24V. P2900-AIW supports cold start at -40°C in arctic region.

Features

VAIR LEDs Technology

VAIR technology is an optical technology to adjust illuminator beam angle by remote control thru RS485 Pelco-D command or manual dip switch to suit diversified camera FOV.

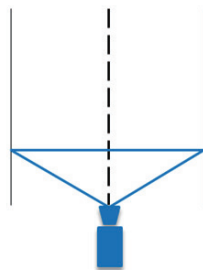
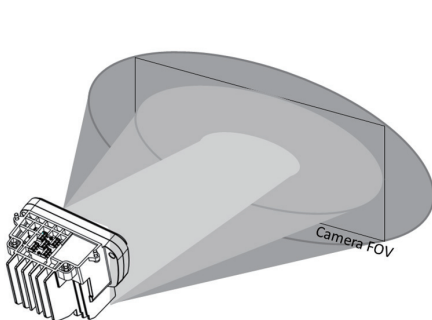

Wide angle for short distance

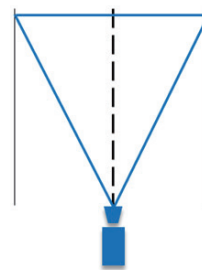

Tele angle for long distance

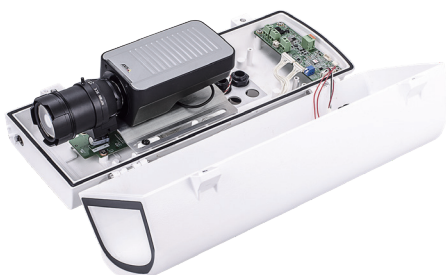

AXIS Q1635 equipped with 8-80mm varifocal lens



Avigilon 8.0-H4A-B2 IP Camera

Specifications

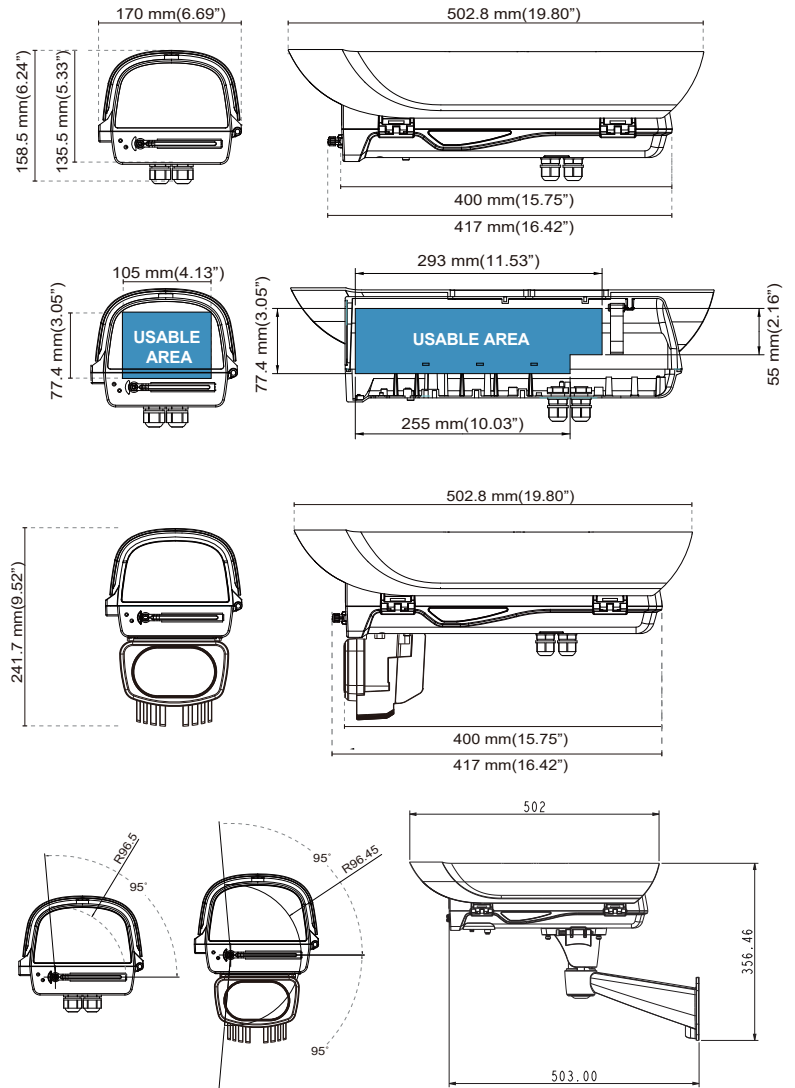

P2900-IW Kit A	
IR Illuminator Specifications	
IR lights catch vehicle speed	MAX: 100km/h (62MPH)
IR lights cover FOV	2 Lanes
VAIR light beam angle	10° ~ 30°
Adjustable angle way	<ul style="list-style-type: none"> Manual DIP Remote control by Pelco D via RS485
IR light sensor sensitivity	Pelco D via RS485
Power consumption	48W
Power input	DC24V
Camera Housing Specifications	
Window heater	V
Blower	V
Wiper	V
Weather rating	IP66
Power input	AC24V
Power output	DC24V, DC12V
Power consumption	72W
Vandal proof	IK10
Operating temperature	-20°C ~ +50°C (-4°F~122°F) Wiper is functional at -10°C to + 60°C (14°F to 140°F)
Optional add-on heater Operating temperature	-50°C ~ +50°C (-58°F~122°F) P2900-AIW is available

Dimensions





Related Product

Power Boxes

Outdoor Powe Box	Outdoor Power Box / Junction Box
 <p>PB-024-1AC Outdoor Power Box</p> <ul style="list-style-type: none"> IP67/IK10 115VAC / 230VAC Input AC24V/6A Output -40°C ~ 60°C 	 <p>PB-024 -2AC Outdoor Power/Junction Box</p> <ul style="list-style-type: none"> IP67/IK10 115VAC / 230VAC Input AC24V/6A Output -40°C ~ 60°C

Accessories

Mount Brackets

Pole Mount	Corner Mount
 <p>AT-100 Pole Mount Adapter</p>	 <p>AT-101 Pole Mount Adapter</p>
	 <p>AT-200 Corner Mount Adapter</p>