

SD-504

SD-524



SD-524



SD-504

Managed IP 802.3af/802.3at/802.3bt/UPoE
1G/2.5Gbps Modular PoE Surge Protectors

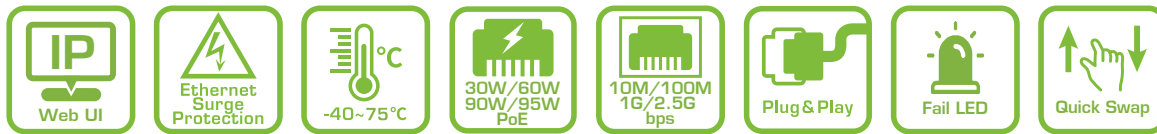

The use of surge protectors to protect sensitive and expensive equipment from lightning strikes and surges on Ethernet cables has become very important. SD-504 and SD-524 are Managed PoE surge protectors, it is designed with smart GUI and quick swap replacement system. The smart GUI provides the quick overview of the surge module life status for easy and efficient maintenance. The quick swamp replacement system allows you to swap the modules without removing the entire unit from the din-rail or the rack. SD-504 and SD-524 keep your valuable PoE switches, PoE PDs and any other IP devices safe from lightning and other forms of electrical interference such as power surges and spikes over networking cables. These 2 models are fully compatible with 802.3af/802.3at/802.3bt/UPoE standard, providing protection to both Ethernet data and PoE power feed, these include outdoor IP cameras, wireless AP and other networking devices. These harden-graded PoE surge protectors operating between -40°C and 75°C during harsh weather conditions, plug-and-play design defends the surge up to 20KV / 10KA easily.

Features

- Web UI Setup
- Alarm log event
- Slide-in modular design
- Quick swap when life time of single PoE surge module is expired
- Supports 10M/100M/1G/2.5G bps Ethernet
- Supports 802.3af / 802.3at / 802.3bt / UPoE
- Protects eight wires of networking cable including PoE
- Protects up to 20KV / 10KA surge
- Failure LED indicator
- Operating temperature between -40°C to 75 °C

Surge Current vs Impulse Number

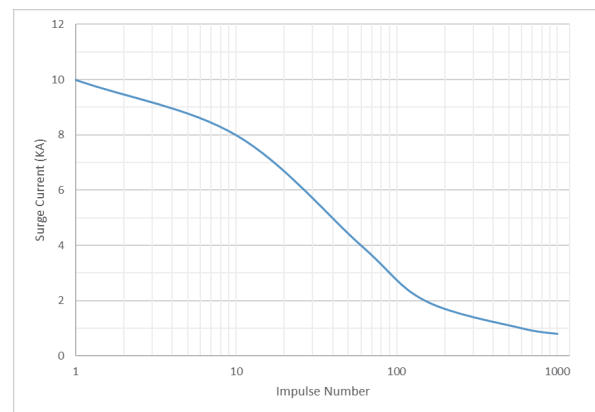

Web UI

• PoE Surge Alarm Setting

Surge Settings

Surge protector module list

Channel	Module Life Time	Surge Counter	Reset Counter	Status	Alarm	Alarm Log Trigger	Location
1	20%	60	<input type="radio"/> Reset <input checked="" type="radio"/> Accumulate	Alarm	OFF	20%	SURGE0
2	0%	100	<input type="radio"/> Reset <input checked="" type="radio"/> Accumulate	FAIL	OFF	20%	SURGE1
3	80%	10	<input type="radio"/> Reset <input checked="" type="radio"/> Accumulate	NORMAL	OFF	20%	SURGE2
4	100%	0	<input type="radio"/> Reset <input checked="" type="radio"/> Accumulate	NORMAL	OFF	20%	SURGE3

- PoE Surge Module Life Time



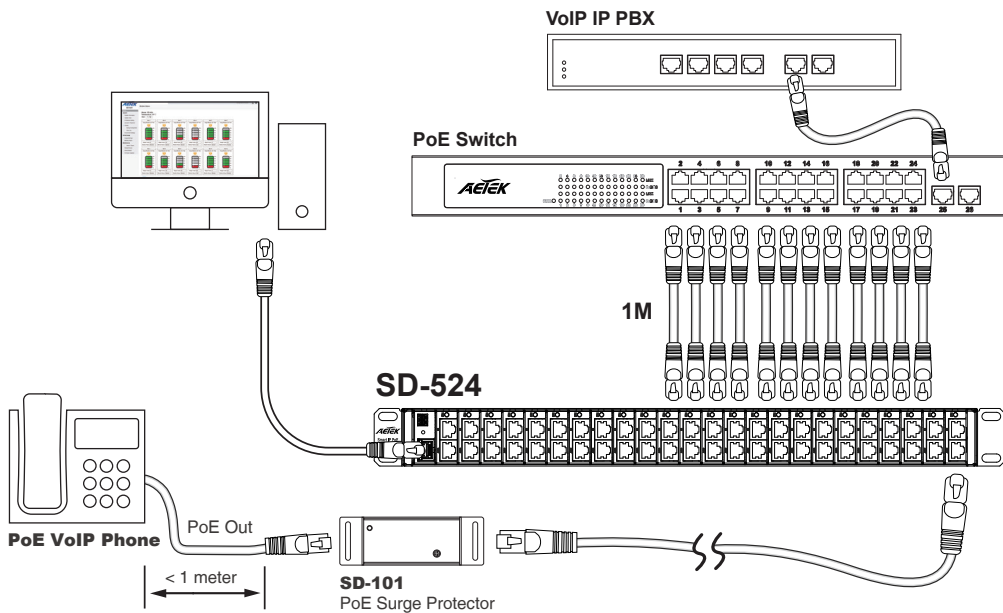
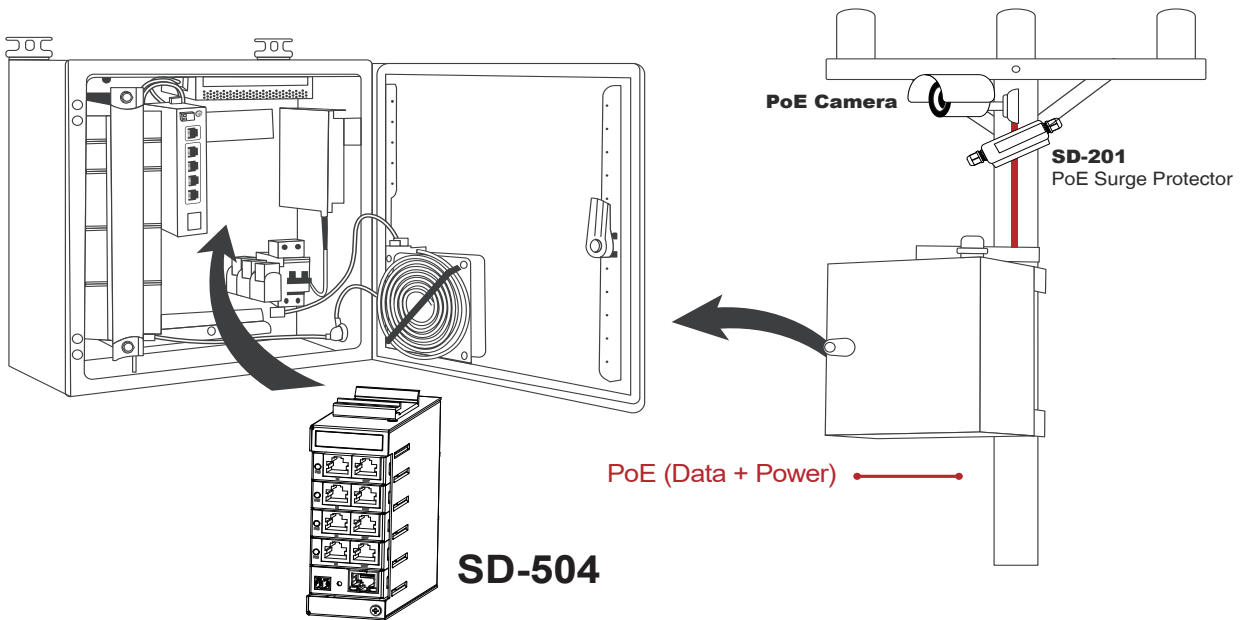

Applications



Specifications

	SD-504	SD-524
Networking Specifications		
Fast Ethernet Port	1	1
Bandwidth	10/100Mbps	10/100Mbps
Auto-MDI/MDI-X, Auto-Negotiation	Supported	Supported
Surge Specifications		
PoE Surge Channel	4	24
Pass Through Data Rates	10M/100M/1G/2.5G bps	10M/100M/1G/2.5G bps
Transmission Media	Cat. 5e,6 UTP/STP	Cat. 5e,6 UTP/STP
PoE Support	802.3af / 802.3at / 802.3bt / UPoE	802.3af / 802.3at / 802.3bt / UPoE
Max Discharge Current (8/20us)	10KA	10KA
Maximum Operation DC Voltage	60VDC	60VDC
Maximum Operation DC Current	1A for 2 pair, 2A for 4 pair, 95W maximum	1A for 2 pair, 2A for 4 pair, 95W maximum
Common Mode Protection Level (10/700us)	20KV	20KV
Differential Mode Protection Level (10/700us)	4KV	4KV
Clamping Voltage (Line to GND)	600V	600V
Clamping Voltage (Line to Line)	20V	20V
Insertion Loss @ 10MHz/100MHz	1db	1db
Return Loss @ 10MHz/100MHz	-20db	-20db
Response Time	5ns	5ns
Power Specifications		
LED Indicators	LAN , SYS, Fail	LAN , SYS, Fail
Power Input	12~56V DC Power Input Removable Terminal Block (Not include power supply)	12~56V DC Power Input Removable Terminal Block (Not include power supply)
Power Consumption	10W	24W
Installation	DIN-rail Mounting	19" rack Mounting
Mechanical Specifications		
Dimensions (L x W x H)	113 x 107 x 44mm	482 x 107 x 44mm
Weight	0.6KG	3KG
Connectors	reset x1pc, Power Terminal Blockx1pc, RJ45 x 9pcs	reset x1pc, Power Terminal Blockx1pc, RJ45 x 49pcs
Environmental Specifications		
Operating Temperature	30W/60W @ -40°C~75°C (-40°F~167°F) 90W @ -40°C~50°C (-40°F~122°F)	30W/60W @ -40°C~75°C (-40°F~167°F) 90W @ -40°C~50°C (-40°F~122°F)
Storage Temperature	-40°C~ 75°C (-40°F~ 167°F)	-40°C~ 75°C (-40°F~ 167°F)
Operating Humidity	Operating: 5~95% (Non-condensing) Storage: 5~95% (Non-condensing)	Operating: 5~95% (Non-condensing) Storage: 5~95% (Non-condensing)
Certifications		
EMC	CE, FCC, VCCI, C-Tick	CE, FCC, VCCI, C-Tick
Surge	ITU-T K.21 IEC-61643-21 IEC-61000-4-5 TIA-968-A (FCC Part68)	ITU-T K.21 IEC-61643-21 IEC-61000-4-5 TIA-968-A (FCC Part68)

Related Products

Surge Protectors			
	SD-501-M • 1-CH PoE Surge Protector Modular • 10/100/1000M/2.5Gbps, 20KV Surge Protector		SD-504 • 4-CH PoE Surge Protector Modular • 10/100/1000M/2.5Gbps, 20KV Surge Protector
	SD-524 • 24-CH PoE Surge Protector Modular • 10/100/1000M/2.5Gbps, 20KV Surge Protector		SD-524-C • 19" 1U 24-CH Chassis